



1. TRANSPORT MODERNISATION VIA CAEV

- A new era for regional transport & manufacture

- Electrification
- Decarbonisation
- Regionalisation



I Run on Air



I Come in Various Designs



The Veolia commissioned waste vehicle operating in France



2. CAEV TECHNOLOGY

- Unique tailoring & construction

- Science & engineering
- Weight, size & performance
- Range & maintenance



Above: The Research Laboratories

Below:

Left - 2 Cylinder engine

Right - 3 Cylinder engine

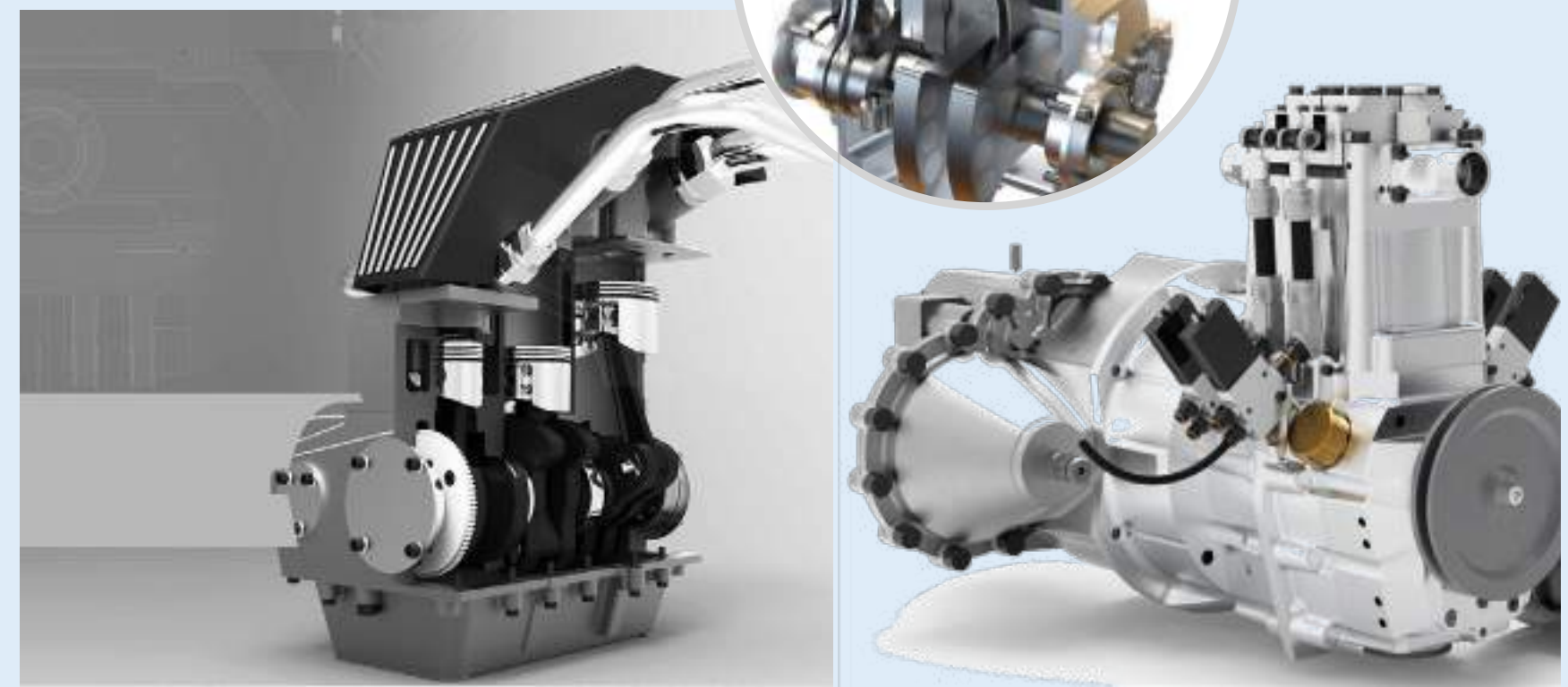



MCAES/TES MODULARITY SYSTEM

- Energy storage, trigeneration, and vehicle propulsion

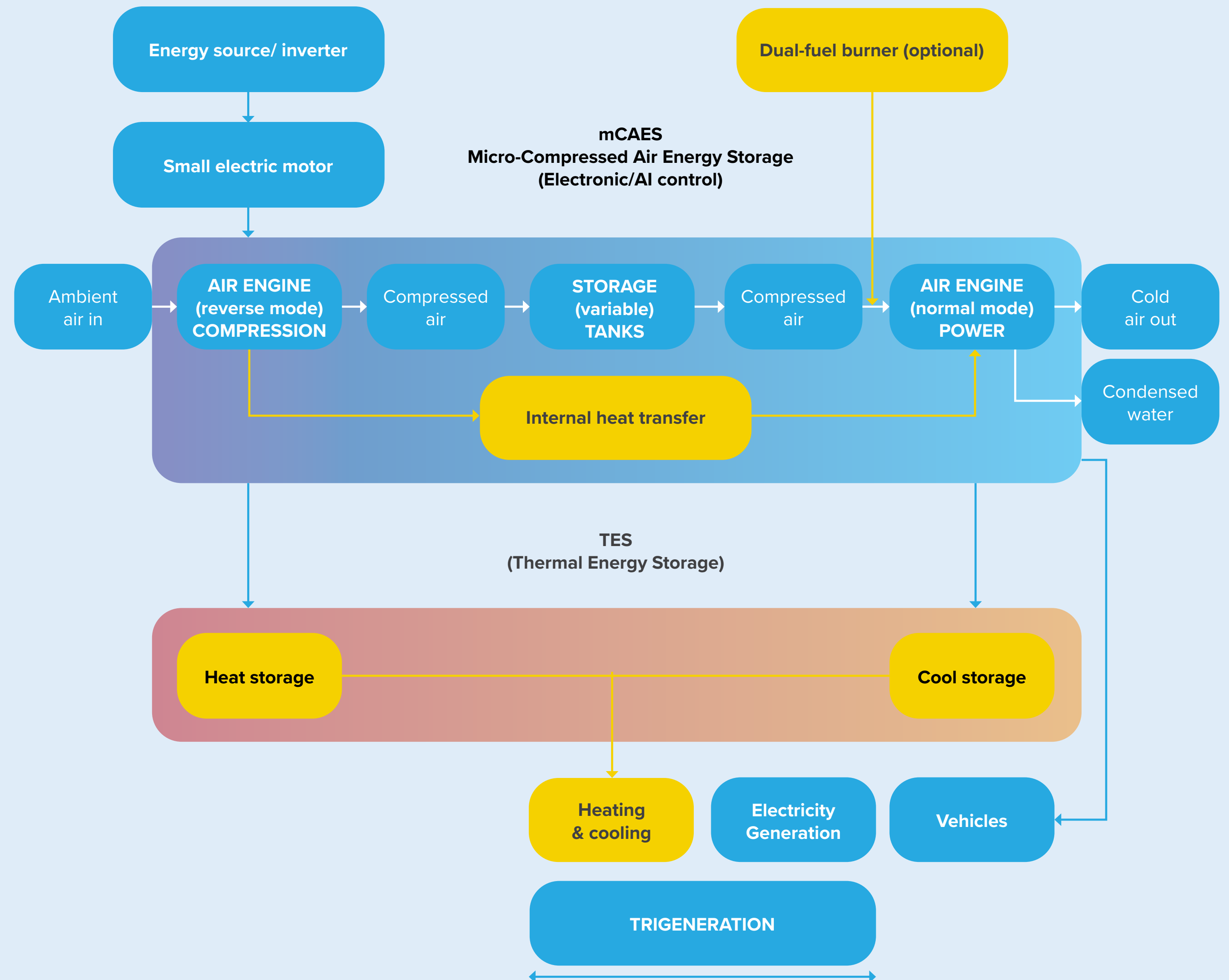



3. ELECTRIC VEHICLE CHALLENGES

- Transitioning ICE legacy to EV

- The overcapacity legacy
- The lagging markets
- Embedded carbons



Above: Hertz is selling 20,000 electric vehicles to buy gasoline cars instead

Below: Money should be linked improving regional targets.
By 2030 we should be aiming for around 50-60% of new vehicles being EVs

Global Spending on the Green Energy Transition Is Climbing
Investments surged 17% in 2023

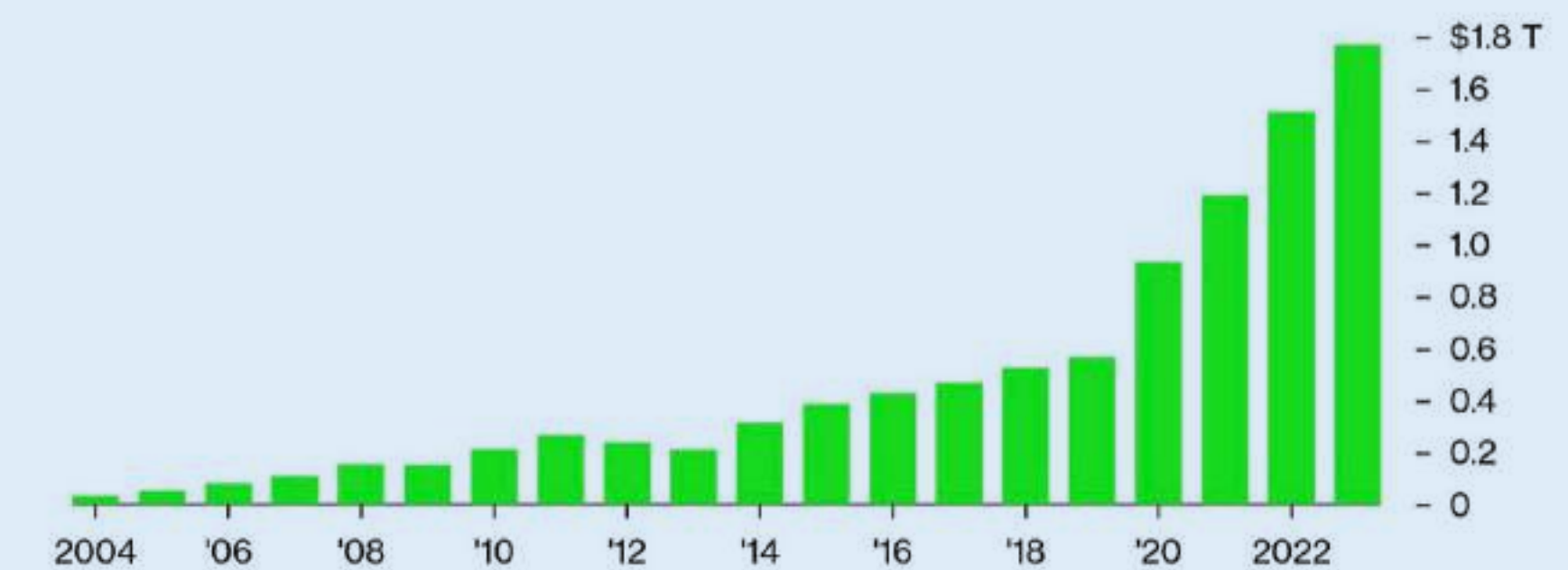

Source: BloombergNEF

Bloomberg Green

Climate embedded carbons from production

CRADLE-TO-GRAVE LIFE CYCLE OF BATTERIES AND ELECTRIC VEHICLES

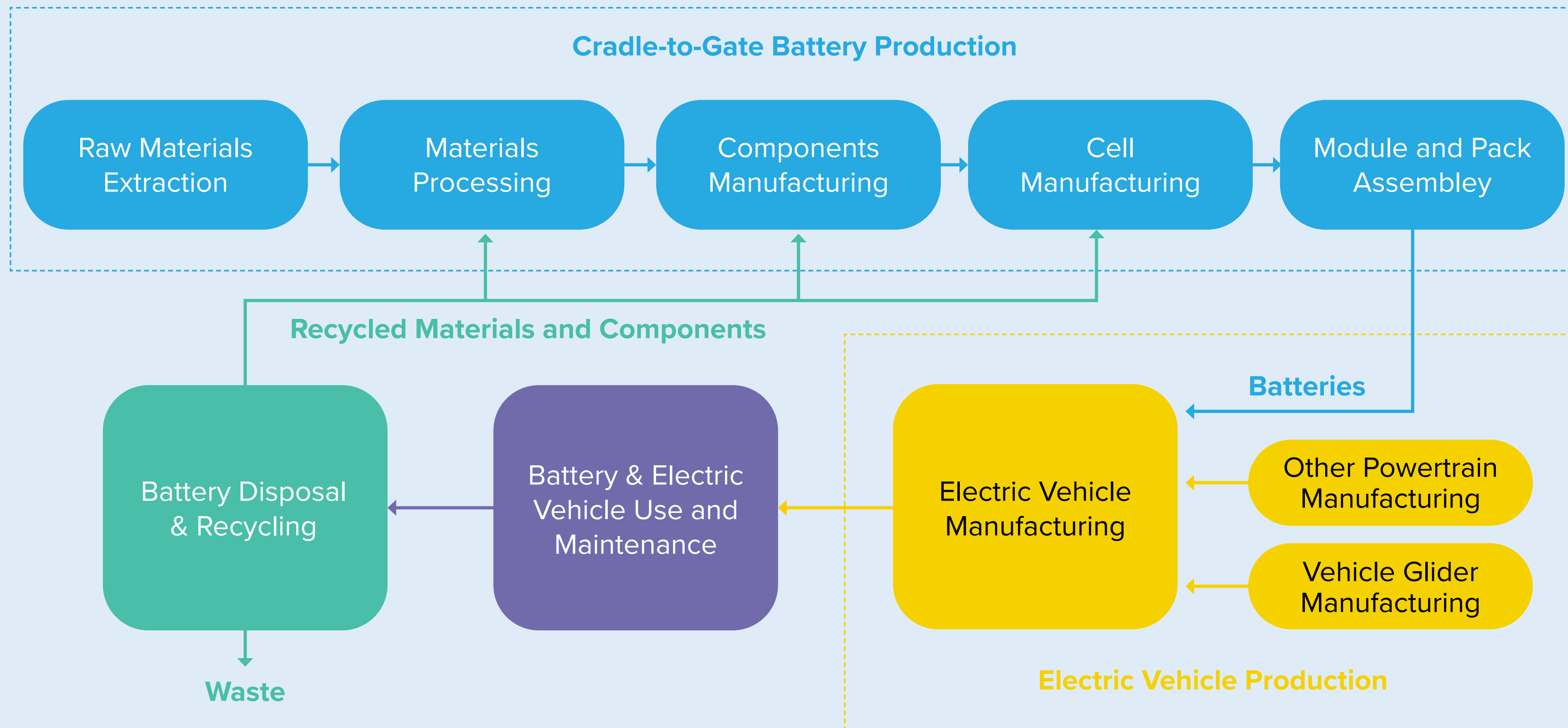



4. REGIONAL VEHICLES POTENTIAL

- Tailoring regional vehicles for all

- Matching
- Niches
- Volume

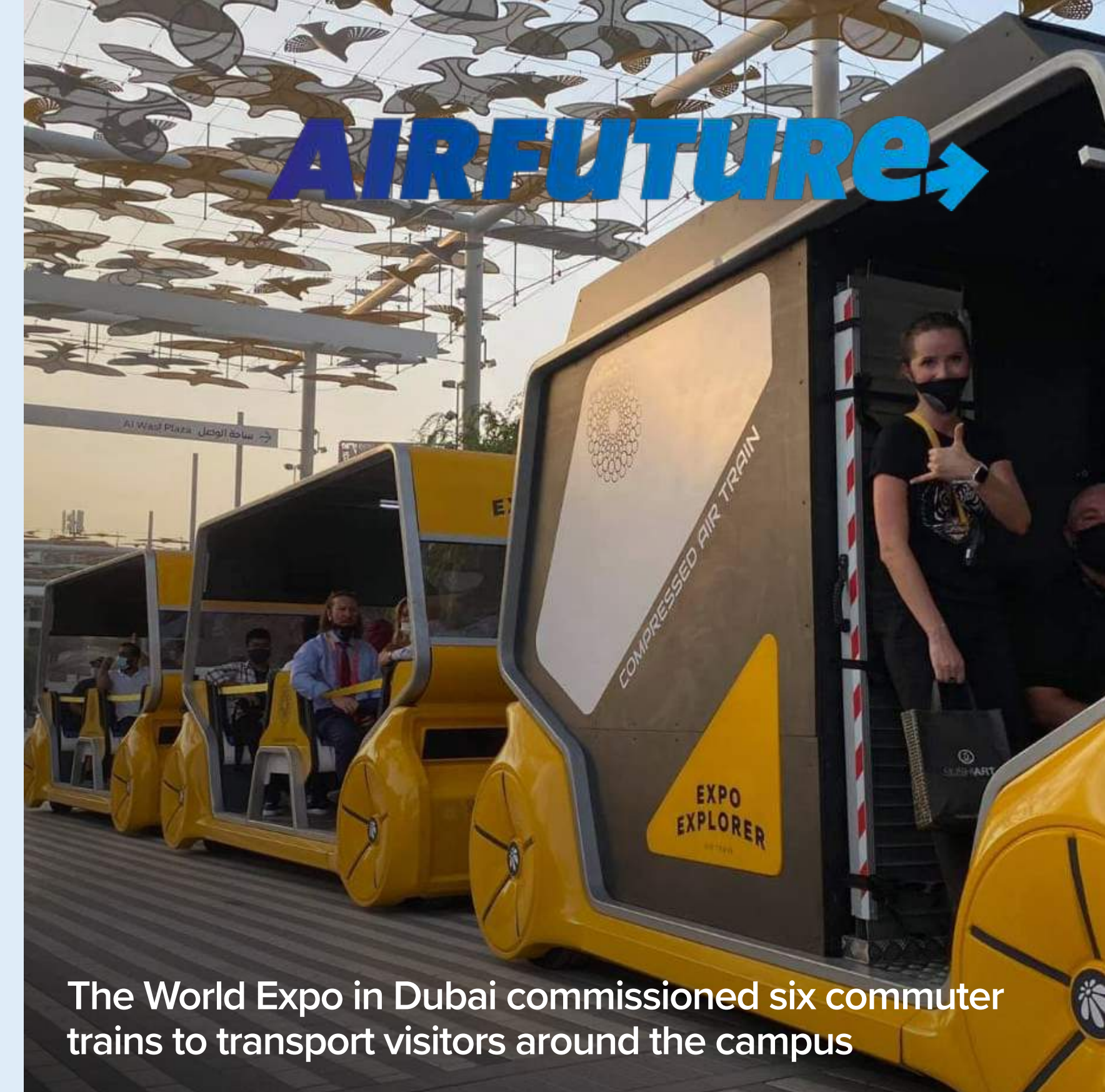

The World Expo in Dubai commissioned six commuter trains to transport visitors around the campus



Assisted by the AirTrain design, ready for mass market applications



Flexible refill designs for very fast refill, plus EV changing networks intended.



5. DISTRIBUTED & REGIONAL MANUFACTURE

- Ownership & benefits to the regions

- Outsourcing manufacture
- Factory manufacture
- Regional industry



Above: Parts & GreenAir manufacture.

Below: Early development factory on open day



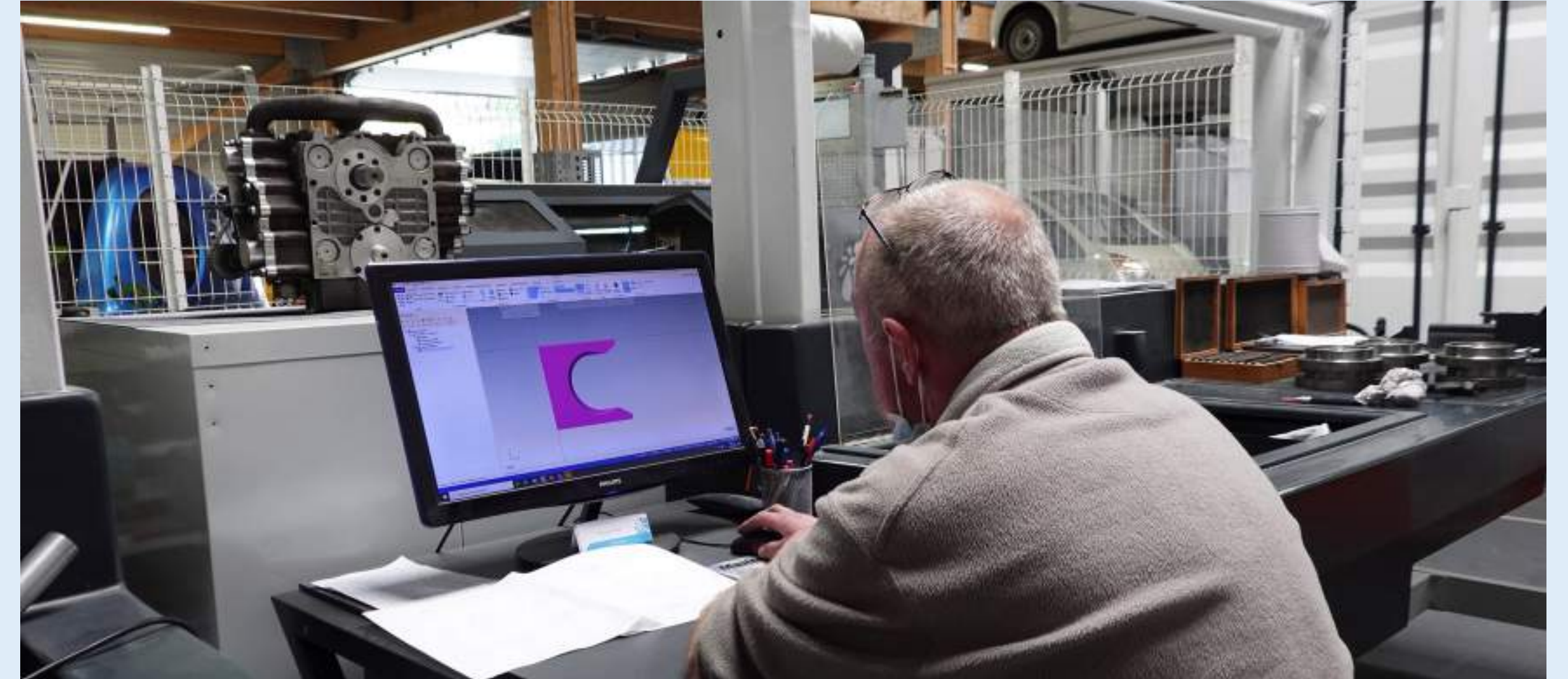

Outsourced manufacture for AirTrain.

6. AUSTRALASIAN SHOWCASE & GLOBAL REPLICATION

- Sponsoring new renewables industries

- Resources & projects
- Replicability & adaptability
- Distributed regional resources

Business resources structure for speedy traction

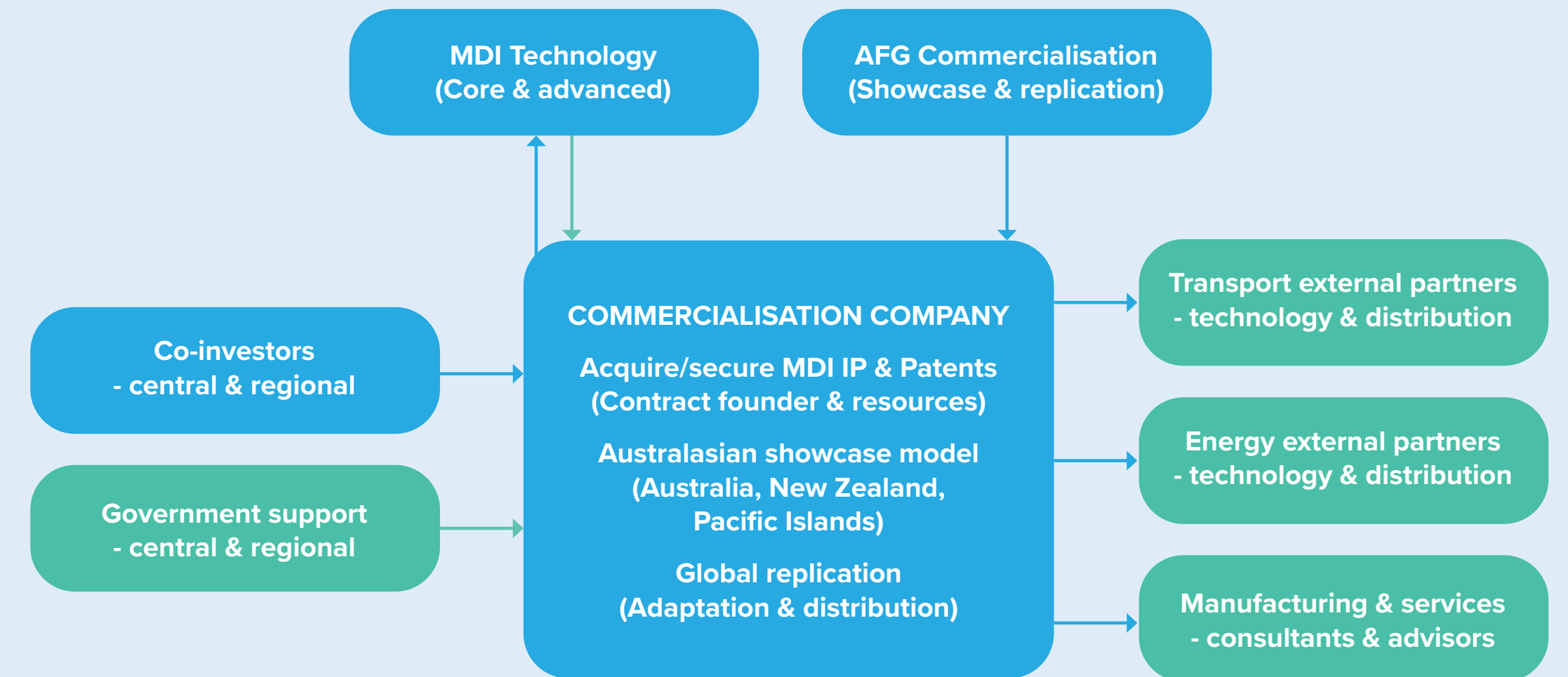

The huge flexibility for cleaning transport.

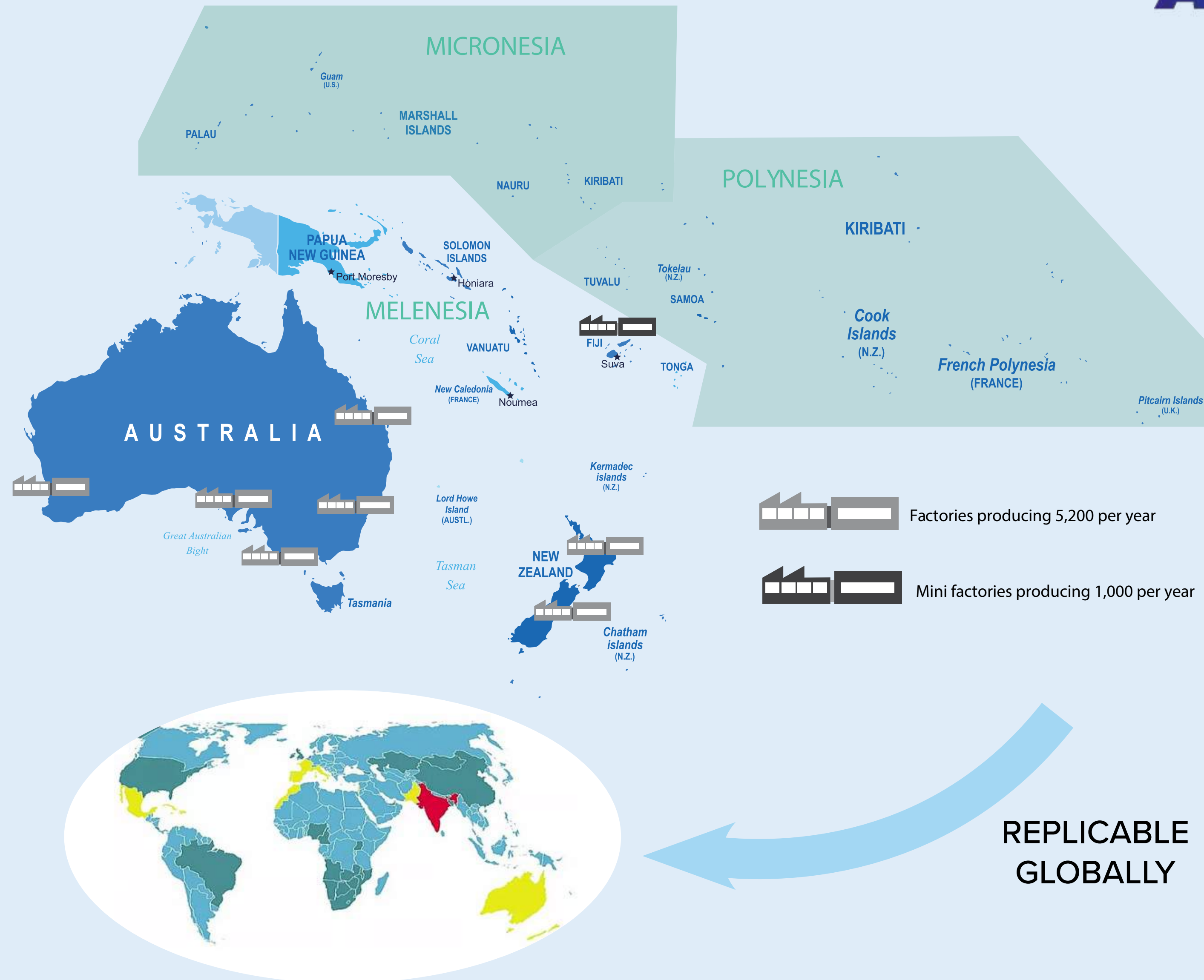

The huge opportunity for Australasia as a global showcase



THE AIR FUTURE & MDI EXECUTIVES IN THEIR EUROPEAN COMMERCIAL WORKSHOPS.



Above: Australian AFG & European MDI in France planning the Australasian showcase.



Above: Chairman Russell Fitts at the wheel of the later CAEV development model AirPod 2.0



Above: CEO John Mennega driving early CAEV on MDI test track in France